

Unit 6, Capitol Industrial Centre,
 Fulmar Way, Wickford,
 Essex SS11 8YW, UK
 Telephone: +44 (0) 1268 573357
 Facsimile: +44 (0) 1268 573358
 Email: salesmds@mirrordoor.co.uk
 www.mirrordoor.co.uk

Mirror Door Systems Ltd

THE TOPAZ/SOLITAIRE READY-MADE RANGE



INSTALLATION INSTRUCTIONS

Before attempting to install Topaz or Solitaire Ready-made Doors read through these instructions carefully. Double-check all measurements ensuring that you have bought the correct doors and track set for the size of wardrobe you have in mind. To achieve a perfect fit demands careful preparation - you will first need to construct an opening of a suitable size.

DO YOU HAVE THE CORRECT DOORS AND TRACK SET? Measure the width and height of the wardrobe opening you have in mind. Use the Door Planning and Track Set Guide opposite to check the number and size of doors you require, and the size of track set you need. Remember, all Topaz and Solitaire standard ready-made doors are designed to fit openings 2270mm high. Opening widths should not be more than 4880mm.

Opening Width	1194 mm	1499 mm	1780 mm	1803 mm	2236 mm	2390 mm	2692 mm	2998 mm	3606 mm
Number & Size Of Doors Required	2x 610 mm	2x 762 mm	3x 610 mm	2x 914 mm	3x 762 mm	4x 610 mm	3x 914 mm	4x 762 mm	4x 914 mm
Track Set Required	1830 mm	1830 mm	1830 mm	1830 mm	2440 mm	2440 mm	3660 mm	3660 mm	3660 mm
Door Plan (viewed From ▲)									

IF YOU HAVE PURCHASED SPECIAL SIZE DOORS - OPENING WIDTH SHOULD BE SUM OF DOOR WIDTHS LESS 25mm (2 DOOR SYSTEM) OR LESS 50mm (3 or 4 DOOR SYSTEM). OPENING HEIGHT SHOULD BE DOOR HEIGHT PLUS 50mm

Adapting The Width

1 FITTING WALL-TO-WALL

In most cases, the distance from wall to wall will only be marginally greater than the width of wardrobe you have selected. If the difference is **less** than 150mm you can narrow the opening by fixing a timber filet up to 76mm thick (x 100mm wide) to each wall.

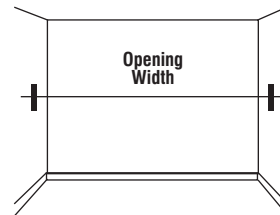

If you have skirting boards, these may prevent the doors sliding flush against the walls. Therefore you should either remove a small section of skirting board, or add a filet.

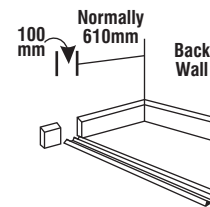

In all cases, we recommend that the space behind the wardrobe doors should be 610mm deep.

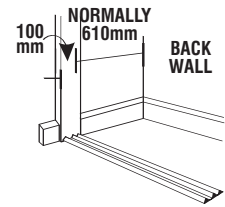

2 FITTING A SIDE PANEL

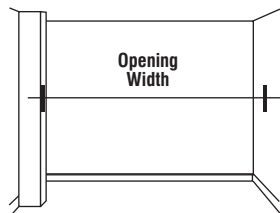

If the distance from wall to wall is **more** than 150mm greater than the wardrobe width you have selected, you will need to construct a side panel. For this, we recommend 100mm x 50mm soft wood studing, faced with plywood or decorative wallboard.

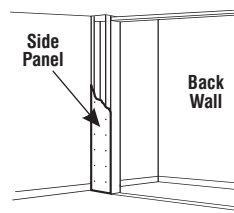

3 FITTING AN END PANEL

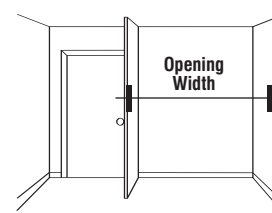

To allow for a window or door at one end of the wardrobe, you should construct an end panel from blockboard or melamine faced chipboard. The panel must be cut to the full ceiling height. Use evenly-spaced plastic joints to hold the panel firmly in position.

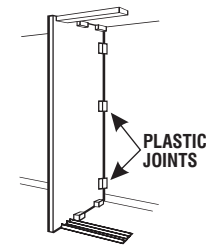

Adapting The Height To Suit Standard Doors

4 FOR A ROOM HEIGHT OF 2270MM

If your actual ceiling height is within 12mm of 2270mm - the tracks can be fitted directly to floor and ceiling.

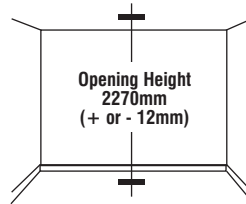

The floor track can be fitted directly on top of carpeting, or other floor coverings. If you have a plasterboard ceiling, cavity fixings should be sufficient to hold the top track in place.

5 FOR ROOM HEIGHT OVER 2270MM

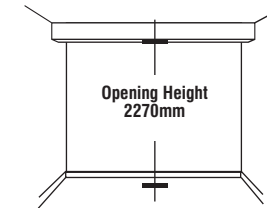

You should reduce the effective height of the ceiling to 2270mm by fitting a timber batten, or box beam. You also have the option of fitting an additional timber plinth beneath the floor track.

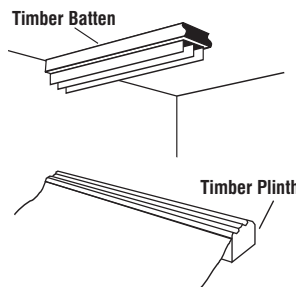

6 FOR A SLOPING CEILING

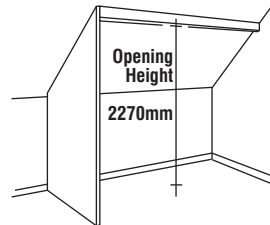

If you want to fix the top track to a sloping ceiling, you will require a timber filet, shaped to match the incline of the ceiling. This should be fixed horizontally to the rafters at a height of 2270mm.

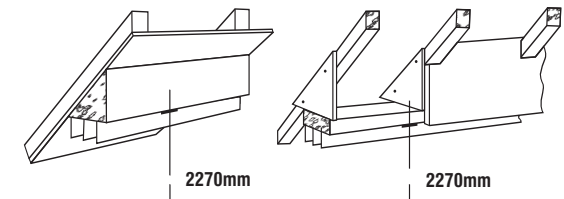

CUTTING AND FIXING TOPAZ AND SOLITAIRE

7 CUTTING TRACKS TO WIDTH

Using a set square and tape measure, mark up the tracks with the correct opening width. Cut with a fine tooth hacksaw.

Bottom Track Support Batten

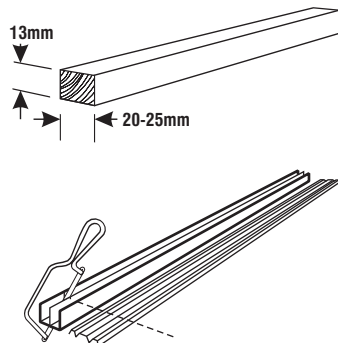

8 GETTING THE POSITION OF THE TRACKS RIGHT

Ensure tracks are both level and parallel. If the planned internal depth of your wardrobe is 610mm, the rear face of the top track should be fixed 610mm from the back wall; the front face of the bottom track should then be fixed 16mm back from the front face of the top track.

Install bottom track support batten direct to the floor, set back 41mm from the front line of the top track, attach the bottom track to the batten using 8g x 32m posi-drive screws.

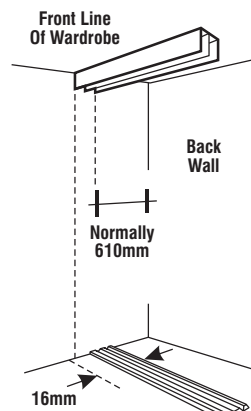
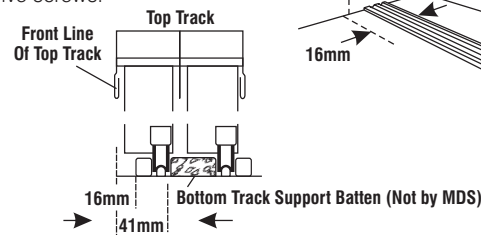

9 TRACK FIXING SOLUTION

One of the benefits of Topaz and Solitaire is that being a bottom rolling system, the top track does not carry the weight of the doors. The ceiling therefore will not require the same reinforcement that a top hung system often requires.

Most modern ceilings are now made out of plasterboard and cavity fixings will be sufficient to hold the top track firmly in place.

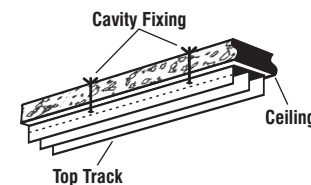

10 PUTTING THE DOORS IN PLACE

Lift the doors into the top track and place the wheels in the bottom track.

(Note: Adjust the door clear of the bottom track before sliding the door.)

Fine adjustments can be made using the wheel bracket adjustment screws on the bottom of each panel. The door panels should be adjusted so that they run smoothly and silently, and are parallel to the side jamb.

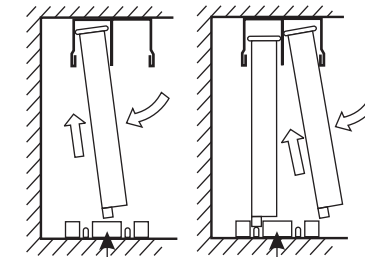

Bottom track support batten located under centre of bottom track profile.

